

30KW750V/1000V AC-DC Movable EV charger

Product Specification

Product model: MC30750HG(GB/T) MC30750HE(CCS2) MC30750HA(CCS1) MC30750HJ(CHAdeMO)

MC301KHG(GB/T) MC301KHE(CCS2) MC301KHA(CCS1) MC301KHJ(CHAdeMO)

Version: V1.1

Date: 2023-01-12

Guangzhou Max Power New Energy Technology Co., LTD

25 Guangxing Road, Nansha District, Guangzhou City, Guangdong Province, China

www.mxpnet.com

Catalogue

1.Overview.....	2
2.Safety instructions.....	3
3.Appearance and Composition.....	4
4.Detailed technical parameters.....	4
5.Package diagram.....	5
6.Instructions for.....	6
7.Precautions for Use.....	8
8.The appendix.....	9

1.Overview

1.1 Introduction

Dear customer, thank you for using the DC charger produced by our company . We sincerely hope that this product can meet your requirements, and look forward to your more valuable comments on the performance and function of the product. We will continue to improve and improve the quality of the product.

1.2 Product model explanation:

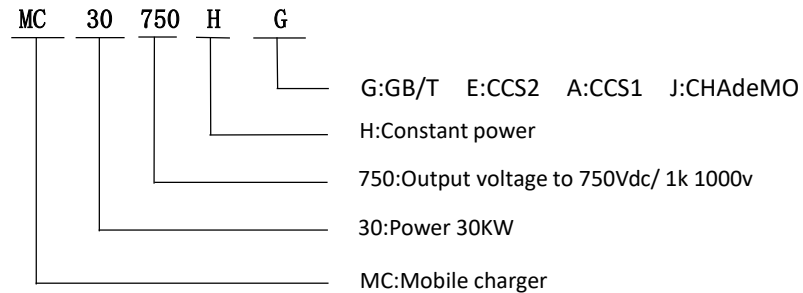

2.Safety instructions

- Charging operation shall follow the operation instructions provided by the company;
- Non-professionals are strictly prohibited to open the charging machine cabinet at will; Do not disassemble or assemble without permission;
- When stopping midway, manually click the button to stop and then pull out the charging interface;
- It is strictly forbidden to insert and remove the charging interface head directly in the charging process, otherwise it will burn out the charging interface head and charger;
- Any operation unrelated to charging is prohibited in the charging process, and other operations can be carried out only when the charging interface head is disconnected from the car and the charger button is clicked to stop.
- Avoid fireworks (open fire) near the charger and pay attention to ventilation;
- The fuse must be replaced with the same type of product, not with copper, iron wire replacement;
- There is high voltage in the charger, and any fault should be repaired by professional personnel to avoid danger;
- The superior circuit breaker and distribution device of the charger shall be selected, installed and operated by professional electrical personnel;
- In severe weather such as thunderstorms, you are advised to disconnect the power supply. If water accumulates in the charger, contact the personnel of the manufacturer to handle the water before continuing to use the charger.
- The unit weight of the charging interface cable is large, and the long cable is easy to drag force in the actual charging process, which is not conducive to releasing the twisting force, increasing the risk of cable distortion and bulge, and affecting the service life of the product. Therefore, do not

pull or twist the charging cable. The cable of the charging interface must be smoothed and not twisted to force the charging interface holder during use.

-Do not shake the charging interface from side to side when inserting or removing the charging interface. Insert and remove the charging interface vertically.

-If any of the following conditions occur, please turn off the power in time and notify professional personnel for repair:

- Abnormal sound appears inside the charger;
- Odor or smoke from inside the charger;
- No display or response on the charger screen;
- The charger has an unrecoverable fault alarm;



Note: Before powering on and running, ensure that the equipment shell is effectively connected to the earth, otherwise there may be electric shock risk!

3. Appearance and Composition



The color and shape of the charging interface and cable will differ according to different batches and manufacturers, so it is not specified.



4.Detailed technical parameters

Item		MC30750	MC301K
Input	Voltage range	260-475Vac 380Vac(rated)	
	Working frequency	45-65HZ	
	The power factor	≥0.99	
	Input current	0-45A	
	Input cable length	5m	
Output	Power	30KW	
	Auxiliary power supply	GB/T:12V/24V CCS1 CCS2 CHAdeMO:12V	
	Voltage range	200-750Vdc	200-1000Vdc
	Maximum current	0-100A	0-100A
	Charging interface cable	GB/T:3m CCS1 CCS2 CHAdeMO:5m	
The work environment	Temperature range	-20~50℃; 25℃ (type)	
	Humidity range	5~90RH%; (non-condensation)	
	The altitude	2000M	
Dimensions and protection	Machine size(mm)	580*180*430mm (Excluding head, handle and casters)	
	Packing size(mm)	Carton:860*440*540mm Wooden box:860mm*440mm*550mm	
	Packing/weight	N.W: 59KG Carton G.W: 61KG Wooden box G.W: 73KG The above weight is only a reference weight for standard configurations. If the weight is increased due to accessories, the actual weight will prevail	
	IP	IP44	
The human-computer interaction		4.3 "color touch screen / Digital tube	
Charging mode		Plug and play	
Charging standard		GB/T: GB/T 18487 、GB/T 20234、GB/T 27930	
		CCS: EN61851、EN62196、ISO15118、DIN70121	
		CHAdeMO: CHAdeMO	

5.Package diagram



Carton



Wooden box

6. Instructions for

6.1 Connect cables before power-on

Content	Specification	Reference picture
L1(Live wire1)	3*10+2*6mm ²	
L2(Live wire2)		
L3(Live wire3)		
PE(Earth wire)		
N(Naught wire)		

- The input cable can adopt neutral line and ground line less than the live line.
- Strictly follow the above label to connect the corresponding circuit breaker position, do not connect wrong cables, otherwise the machine will burn;
- When the AC input line of the charger is connected to the circuit breaker, the circuit breaker and the circuit breaker of the charger must be closed, and then open successively after confirming the connection;
- The user must make sure that the load locking screw must be locked and not loose;
- If you encounter the phenomenon of pushing open tripping, do not force the brake to push again, be sure to find out the cause before you can push again;
- The grounding wire must be connected to prevent human body electric shock and safety when there are grounding conditions.

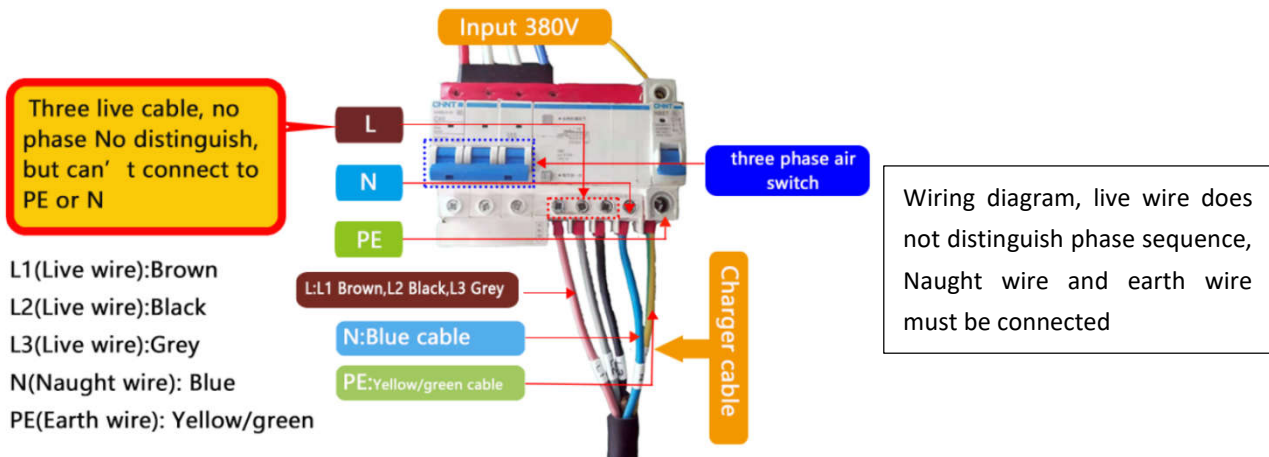

6.2 Charging



Step 1: Plug in the charging interface



Step 2: Switch the input line to ON



Step 3: Turn ON the back of the charger to ON



Step 4: Welcome charging interface

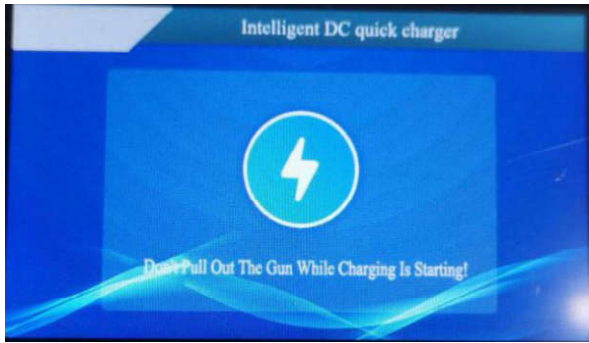

Step 5:connecting

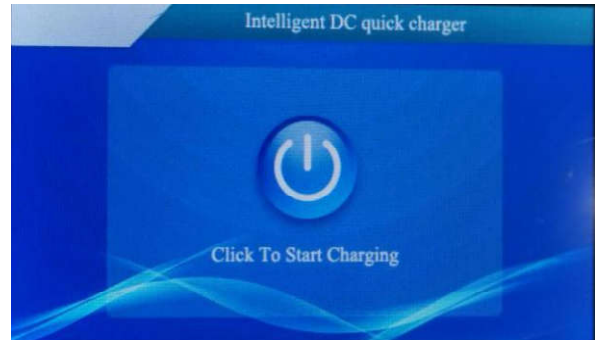

Step 6: Enter the start up interface

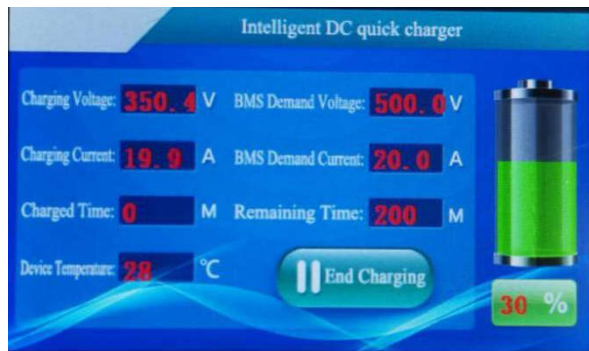

Step 7: Charging interface

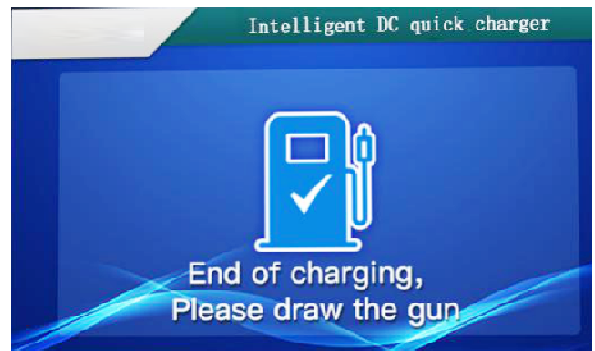

Step 8: Draw interface, charge completed

6.3 Fault display interface

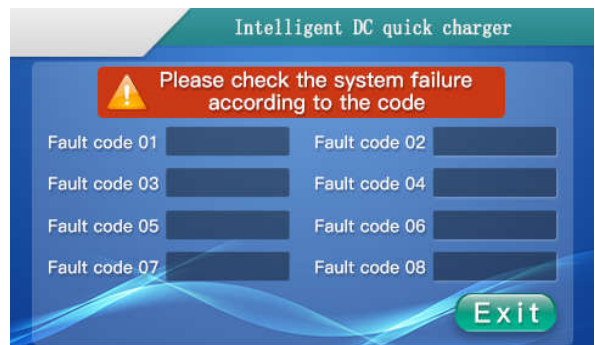
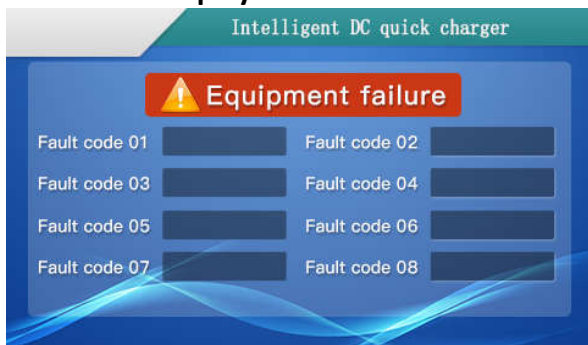

6.4 Routine maintenance table

Check content	Check the method	Maintenance cycle
General operating status and environment of the system	<ol style="list-style-type: none"> 1. Observe whether the components, circuit and device structure of the charger are damaged or deformed; 2. Listen to whether there is any abnormal sound when the charger is running; 3. Check whether the data display on the touch screen is normal. 4. Check whether the switch, contactor, circuit breaker, and fan are normal. 5. Check whether the heat of the charger shell is normal; 6. Observe whether the inlet and outlet air is normal; 7. Check the humidity and dust around the charger. <p>Attention! Intake ventilation must be checked. If the module is not cooled effectively, it will fail due to overheating.</p>	Once every six months
System clean	<ol style="list-style-type: none"> 1. Check the cleanliness of circuit boards and components; 2. Check the temperature and dust of the internal charging module. Remove the module and clean it if necessary. 	Once every six months to once a year (depending on the dust content of the

		environment)
Power circuit connection	1. Check whether the power cable and control cable are damaged, especially whether the skin in contact with the metal surface is cut; 2. Check whether the insulation bandage of the power cable wiring terminal is off.	Six months after the first commissioning, and then once every six months to a year
Cooling fan maintenance and replacement	1. Check whether there are cracks in fan blades; 2. Listen to whether there is abnormal vibration sound when the fan is running; 3. Replace the fan in time if it is abnormal.	Once a year
Circuit breaker maintenance	1. Check the corrosion of all metal components regularly (every six months); 2. Annual inspection of contactor to ensure good mechanical operation.	Once every six months to a year
Safety features	1. Check the function of emergency stop button and stop button; 2. Simulated shutdown.	Once every six months to a year

7. Precautions for Use

7.1 In the normal charging process, it is strictly forbidden to plug or remove the charging interface with electricity;

7.2 To end charging, you must first press the "Start/Stop" button, pull the interface, and then disconnect the charger to disconnect the mains;

7.3 Do not pull the locked interface out of the socket by brute force to avoid conductive materials such as metal foreign bodies entering the device.

7.4 Non-professionals do not open the charger shell to avoid damage to the charger;

7.5 Pay attention to the BMS power supply voltage of 12V or 24V, and select the corresponding charging model number.

7.6 The charger is equipped with a standard input cable. Users need to connect an external circuit breaker to ensure that the input PE cable is reliably grounded.

7.7 Only when the input power distribution capacity is not less than the rated power of the charger, can the charger be charged at full power.

7.8 Dc charging interface is standard, no need to install it separately;

7.9 Indoor drying is forbidden to be used in rainwater environment;

7.10 If there is a heat source near the charger, please move it as far as possible and take the surrounding space into full consideration to facilitate heat dissipation;

7.11 Avoid steam, dust and metal dust;

7.12 Keep away from flammable, explosive and corrosive gases and liquids;

7.13 Stay away from electromagnetic interference sources.

8. The appendix

8.1 Quality assurance

During the warranty period, the company will repair or replace new products free of charge. During the warranty period, the company requires customers to show the invoice and date of purchase. At the same time, the trademark on the product should be clearly visible, otherwise the right not to give quality assurance. The unqualified products after replacement shall be handled by our company. Customer shall allow company reasonable time to repair faulty equipment.

The company reserves the right not to guarantee quality in the following cases:

- The whole machine and parts have exceeded the free warranty period

- Transportation damage
- Incorrect installation, modification, or use
- Outdoor charging in rainy days leads to water inflow damage of charging pile.
- Extremely harsh operating conditions beyond those specified in this manual
- Machine failure or damage not caused by installation, repair, alteration or disassembly by our service personnel
- Failure or damage of the machine caused by non-standard use or not confirmed by the company
- Any beyond the scope of use specified in the relevant national standards
- Damage caused by abnormal natural conditions



Non-company personnel are prohibited to open the charging equipment, such as personal accidents, property accidents, safety accidents caused by this has nothing to do with the company.

In case of product failure caused by the above situation, if the customer requires maintenance service, the company can provide paid maintenance service after the judgment of the service organization.

8.2 Precautions

- The company does not assume any responsibility for the loss caused by the configuration software products provided with the products.
- Any use of any or all of the data in the firmware or software developed by the company for commercial purposes is prohibited.
- It is forbidden to decompile, decrypt or destroy the original program design of the software developed by the company.